

# ZAXIS

## 30U/35U



# Compact yet Powerful

Hitachi applied all its excavator expertise in the design of the new zero-tail mini excavators ZAXIS30U-2 and ZAXIS35U-2. These machines meet customer demands for operating comfort, enhanced safety and easier maintenance. The series complies with the latest emission regulations, noise suppression standards and ROPS/FOPS standards. Operators have superior control over the machine from the relaxed seat. Owners enjoy a lower cost of ownership due to the machine's durability and easy maintenance.



## Single Swing Pin

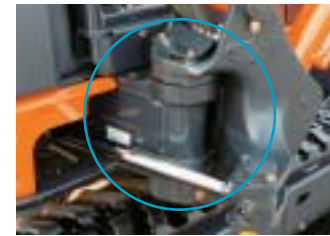

A single large swing pin is used to eliminate jerking.

## Automatic Travel Speed Control at High Speed (Standard)



During high-speed travel, when the load is increased for steering for example, travel speed is lowered automatically and smoothly. When the load is decreased, travel speed is resumed accordingly.

## Enlarged Counterweight and Weighted Undercarriage

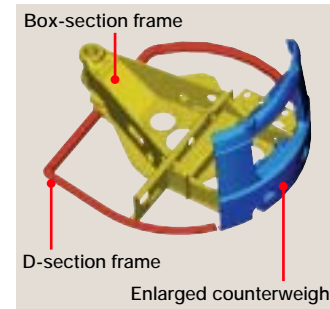

The newly developed box-section frame is adopted, combining low weight and high durability. The enlarged counterweight and weighted undercarriage help lower the center of gravity and increase stability.

## Additional Counterweight (Option)



When using a heavy front attachment such as a fork grapple, the additional counterweight is easily mounted for higher stability.

## New-Structure Rubber Crawlers

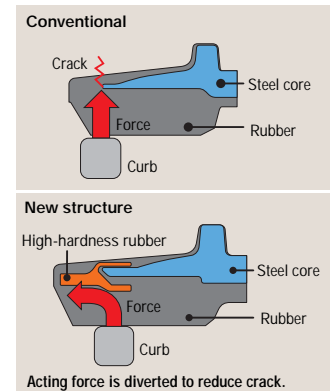

The Hitachi-developed rubber crawlers are highly durable, featuring a steel-cored structure that protects shoe edges from being damaged even when riding on curbs.

## Durable Flat-Bottom Bucket

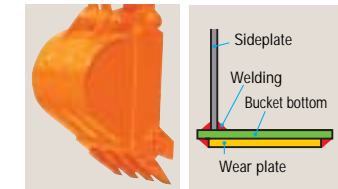

The flat-bottom bucket is provided standard to minimize bucket bottom wear. Wide wear plates are welded to the bucket bottom for increased durability.

## Job-Proven HN Bushings



The field-proven HN bushing, a Hitachi original, is utilized at each front pin joint to reduce jerking and servicing. Lubricating interval is a long 500 hours.

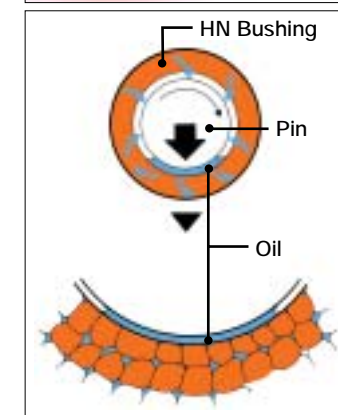

The HN bushing, another example of innovative technology developed by Hitachi, features long life and high durability. High-viscosity oil is vacuum impregnated in sintered high-hardness metal. During operation oil oozes from the pores of the bushing into the clearance between pin and bushing for self-lubrication.

## Auto-Idle Saves Fuel Consumption



When shifting the control lever to neutral, engine speed is lowered to idling speed to save fuel consumption and reduce emissions and noise. This feature is advantage when working in urban residential districts.



## Suitable for a Variety of Applications

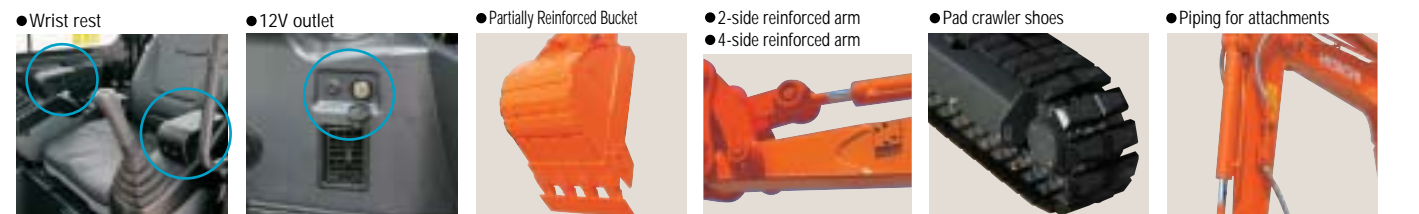

# Operator Comfort and Safety

## ■ Ergonomic Controls

### ● Conveniently Located Foot Pedals



While traveling with foot pedals, the operator can control the front attachment with hands. The foot pedals, when not in use, can be folded away for increased foot space.

### ● Easy-to-Read Monitor



The operator can always check machine conditions at a glance. Fuel level, coolant temperature and the status of various other indicators are clearly displayed on the large LCD monitor placed in the front right position.

### ● Functionally Located Switches



Various switches are located within reach of the operator for convenience of the operator without need for repositioning.



## ■ Miscellaneous Devices



- Seat backrest box
- Drink can holder
- Seat belt



- Ashtray (cabin)
- Tool box (canopy)
- Slip-resistant tape



## ■ Improved Visibility with Roof Sun Visor (Canopy)



The Sun visor, an integral part of the roof, gives better upward visibility. The overhang roof keeps the operator's knees dry in light rain.

## ■ Pilot-Control Shut-Off Lever



All operations—front, swing, travel and blade—can be shut off by locking the pilot control shutoff valve. This effectively prevents accidental lever control.

## ■ Rubber Mounted Floor

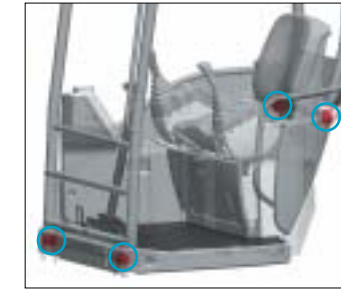

The cabin rests on 4 shock-absorbing rubber mounts to ensure comfortable operation.

## ■ Air Conditioner (Cabin Version)

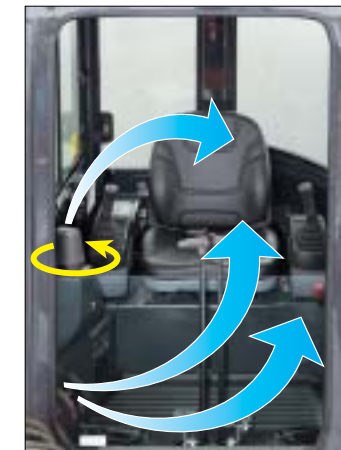

Compact yet ample-capacity air conditioner is provided standard. The full-360° rotatable air outlet also serves as a defroster, maintaining operator comfort all the year round.

## ■ Folded Large Cabin Door



The door opens in two steps and has increased width of 610 mm, allowing easy entry.

## ■ ROPS/FOPS Cabin and Canopy

Both canopy and cabin conform to the latest ROPS, FOPS and TOPS standards. These protect the operator in case of roll-over; tip-over and from falling objects. The seat belt protects the operator as well.

The operator's cabin and canopy, complying with the international standards, are mounted to protect the operator in the case of tipping.

## ■ Neutral Engine Start System

The engine can start only when the pilot control shutoff lever is locked. This is called the neutral engine start system. This eliminates unexpected lurching when the engine suddenly starts when unconscious touching the control lever.

## ■ Swing/Travel Parking Brakes (Standard)

The swing parking brake and travel parking brake are both provided standard for enhanced safety.

# Easy Maintenance

## ■ Tilt-Up Floor

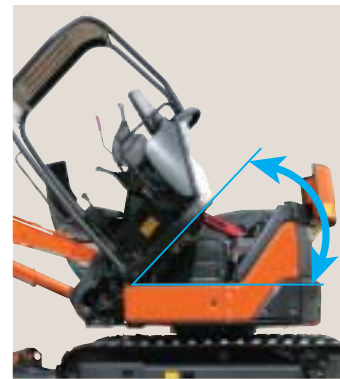

The cabin floor can be tilted up for easy, quick servicing even in the case of an emergency. The floor can be tilted up to 50° to allow the operator to work under the cabin floor. It also gives direct access to the swing mechanism and starter motor behind the engine located under the cabin floor. This design reduces inspection and maintenance time.

## ■ Simplified Daily Maintenance

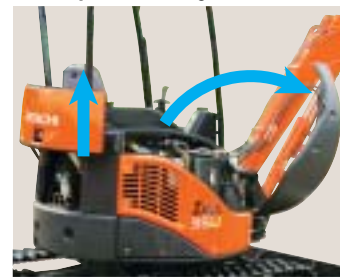

The engine cover can slide up and down for quick servicing even in confined space. No more swing-open cover that obstructs maintenance and servicing jobs. The right side cover swings open for a quick battery check.

## ■ Uses Tracks Promoting Easy Mud Removal

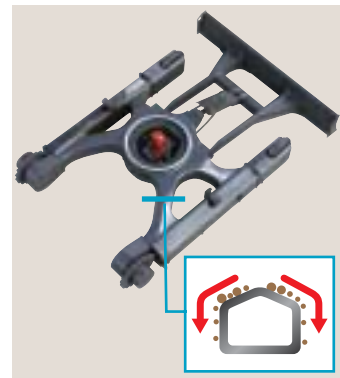

The X-beam track frame is rounded for smooth mud removal. One-sided slope on the side track frame promotes mud sliding-off, minimizing mud packing problem. This shortens machine washing time and reduces disposal costs, too.

## ■ Reinforced D-Shaped Frame

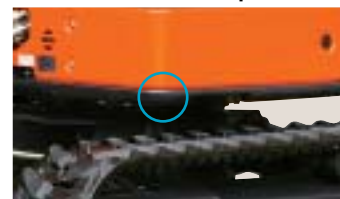

The machine frame is reinforced with a D-shaped frame that protects against damage and impact by obstructions.



## ■ Easy to Repair Steel Cover



A steel cover is utilized for tough operation, allowing easy repair if damaged. The steel cover is durable, recyclable and economical.

## ■ Split-Type Front Hoses

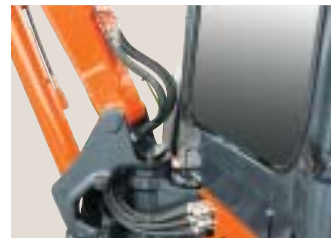

Split-type front hoses are jointed at the machine cover ports and the back of the boom for easy replacement.

# Parts and Service

Over the years Hitachi gained experience in one of the most competitive service markets in the world: Japan. Using our know-how in dealing directly with customers, we have created a worldwide support system that is highly effective and efficient. More than 150 dealers all over the world have highly trained technicians and high parts availability. Contact your Hitachi dealer for detailed information about service programs available for your area and machine. Not all services and/or programs are available in every region or for all machines.



To get the most out of your machine, you need genuine Hitachi parts. In most cases there is a Hitachi dealer in your area that has the required part in stock. Hitachi minimizes the delivery time for any part by connecting its 4 parts depots in Japan, Singapore, The Netherlands and North America by a on-line system sharing information on the number and type of available parts. In this way you are ensured that your parts are shipped as efficiently and quickly as possible.

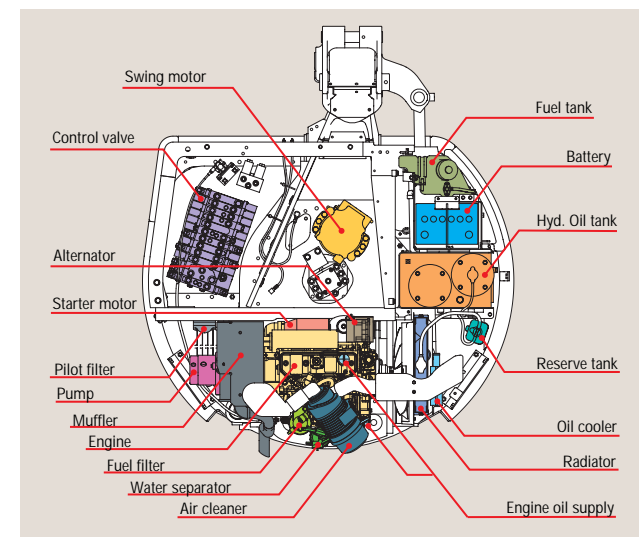

The Zaxis30U-2 and Zaxis35U-2 share the same device layout for easy, efficient inspection and replacement. Inspection points are concentrated for quick daily maintenance.

# SPECIFICATIONS

## ENGINE

|                           |   |
|---------------------------|---|
| Model .....               | Yanmar 3TNV88   |
| Type .....                | Water-cooled, 4-cycle, 3-cylinder direct injection type diesel engine |
| Rated power               |   |
| SAE J1349 .....           | 22.3 kW (29.9 HP) at 2 500 min <sup>-1</sup> (rpm)                    |
| DIN 6271 .....            | 22.1 kW (30.0 PS) at 2 500 min <sup>-1</sup> (rpm)                    |
| JIS D1005 .....           | 22.3 kW (30.3 PS) at 2 500 min <sup>-1</sup> (rpm)                    |
| Maximum Torque .....      | 105 N.m (11 kgf.m) at 1 500 min <sup>-1</sup> (rpm)                   |
| Bore & Stroke .....       | 88 x 90 mm  |
| Piston displacement ..... | 1.642 L   |
| Battery .....             | 1 x 12 V, 55 Ah   |

## HYDRAULIC SYSTEM

The proven 3-pump system and arm regenerative circuit have been improved to make combined operations and fine control easier and smoother.

|                        |  |
|------------------------|--|
| Main pumps .....       | Two variable displacement axial piston pumps |
| Maximum oil flow ..... | 2 x 40 L/min                                 |
| Third pump .....       | One gear pump                                |
| Maximum oil flow ..... | 26.3 L/min                                   |
| Pilot pump .....       | One gear pump                                |
| Maximum oil flow ..... | 11.3 L/min                                   |

### RELIF VALVE SETTINGS

|                          |          |
|--------------------------|----------|
| Main pumps circuit ..... | 24.5 MPa |
| Third pump circuit ..... | 20.6 MPa |
| Pilot circuit .....      | 3.9 MPa  |

### HYDRAULIC CYLINDERS

High-strength piston rods and tubes. Cylinder cushion mechanisms provided in boom raise, arm roll-in and roll-out circuits to absorb shocks at stroke ends.

### DIMENSIONS

|             | Quantity | Bore  | Rod diameter | Stroke |
|-------------|----------|-------|--------------|--------|
| Boom Canopy | 1        | 80 mm | 45 mm        | 579 mm |
|             | 1        | 85 mm | 50 mm        | 576 mm |
| Boom Cabin  | 1        | 80 mm | 45 mm        | 563 mm |
|             | 1        | 85 mm | 50 mm        | 564 mm |
| Arm         | 1        | 70 mm | 40 mm        | 546 mm |
|             | 1        | 75 mm | 45 mm        | 597 mm |
| Bucket      | 1        | 65 mm | 40 mm        | 435 mm |
|             | 1        | 65 mm | 40 mm        | 435 mm |
| Boom swing  | 1        | 85 mm | 45 mm        | 525 mm |
|             | 1        | 85 mm | 45 mm        | 525 mm |
| Blade       | 1        | 85 mm | 45 mm        | 135 mm |
|             | 1        | 95 mm | 45 mm        | 140 mm |

Figures in   are data on the ZAXIS30U<sub>2</sub>.

Figures in   are data on the ZAXIS35U<sub>2</sub>.

## CONTROLS

Hydraulic pilot control levers for all operations.

## FRONT ATTACHMENTS

### BACKHOE BUCKETS

| ISO 7451 capacity    | Width                |                   | No. of teeth | Weight | Front Attachment      |            |                       |            |
|----------------------|----------------------|-------------------|--------------|--------|-----------------------|------------|-----------------------|------------|
|                      | Without side cutters | With side cutters |              |        | ZAXIS30U <sub>2</sub> |            | ZAXIS35U <sub>2</sub> |            |
|                      |                      |                   |              |        | 1.17 m arm            | 1.52 m arm | 1.32 m arm            | 1.72 m arm |
| 0.055 m <sup>3</sup> | 300 mm               | 350 mm            | 3            | 60 kg  | A                     | A          | A                     | A          |
| 0.065 m <sup>3</sup> | 350 mm               | 400 mm            | 3            | 65 kg  | A                     | A          | A                     | A          |
| 0.08 m <sup>3</sup>  | 400 mm               | 450 mm            | 3            | 67 kg  | A                     | A          | A                     | A          |
| 0.09 m <sup>3</sup>  | 450 mm               | 500 mm            | 4            | 73 kg  | A                     | A          | A                     | A          |
| 0.10 m <sup>3</sup>  | 500 mm               | 550 mm            | 4            | 76 kg  | A                     | B          | A                     | A          |
| 0.11 m <sup>3</sup>  | 550 mm               | 600 mm            | 4            | 80 kg  | B                     | C          | A                     | B          |
| 0.13 m <sup>3</sup>  | 600 mm               | 650 mm            | 4            | 84 kg  | C                     | C          | B                     | C          |
| 0.14 m <sup>3</sup>  | 650 mm               | 700 mm            | 4            | 87 kg  | -                     | -          | C                     | -          |
| 0.15 m <sup>3</sup>  | 700 mm               | 750 mm            | 4            | 89 kg  | -                     | -          | C                     | -          |
| Arm crowd force      |                      |                   |              |        | 17.2 kN               | 14.7 kN    | 19.1 kN               | 17.2 kN    |
| Bucket digging force |                      |                   |              |        | 27.5 kN               | 27.5 kN    | 27.5 kN               | 27.5 kN    |

A: General digging    B: Light-duty digging    C: Loading

## SWING MECHANISM

High-torque, axial piston motor with planetary reduction gear. Swing circle is single-row, shear-type ball bearing with induction-hardened internal gear. Internal gear and pinion are immersed in lubricant. Swing parking brake is spring-set/hydraulic-released disc type. Swing shockless valve built in swing motor absorbs shocks when stopping swing, ensuring smooth stops.

Swing speed ..... 9.3 min<sup>-1</sup> (9.3 rpm)

## UNDERCARRIAGE

### TRACKS

Tractor-type undercarriage. Welded track frame using carefully selected materials. Side frame welded to track frame.

### NUMBERS OF ROLLERS ON EACH SIDE

|                     |   |
|---------------------|---|
| Upper roller .....  | 1 |
| Lower rollers ..... | 4 |

### TRAVEL DEVICE

Each track driven by a high-torque, 2-speed axial piston motor through planetary reduction gear, allowing counter-rotation of the tracks. Travel shockless relief valve built in travel motor absorbs shocks when stopping travel, ensuring smooth stops.

Travel speeds (rubber shoes) ..... High: 0 - 4.5 km/h  
Low: 0 - 2.8 km/h

Travel speeds (grouser shoes) ..... High: 0 - 4.4 km/h  
Low: 0 - 2.7 km/h

Gradeability ..... 30 degrees (58%) continuous

## WEIGHTS AND GROUND PRESSURE

Equipped with ZAXIS30U<sub>2</sub>: 1.17 m arm and 0.09 m<sup>3</sup> (ISO 7451 capacity) bucket, ZAXIS35U<sub>2</sub>: 1.32 m arm and 0.11 m<sup>3</sup> (ISO 7451 capacity) bucket.

|                       | ZAXIS30U <sub>2</sub> |                 | ZAXIS35U <sub>2</sub> |                 |
|-----------------------|-----------------------|-----------------|-----------------------|-----------------|
|                       | Operating weight      | Ground pressure | Operating weight      | Ground pressure |
| <b>Canopy version</b> |                       |                 |                       |                 |
| 300 mm rubber shoes   | 3 070 kg              | 28 kPa          | 3 480 kg              | 31 kPa          |
| 300 mm grouser shoes  | 3 160 kg              | 29 kPa          | 3 570 kg              | 32 kPa          |
| <b>Cabin version</b>  |                       |                 |                       |                 |
| 300 mm rubber shoes   | 3 220 kg              | 29 kPa          | 3 630 kg              | 33 kPa          |
| 300 mm grouser shoes  | 3 310 kg              | 30 kPa          | 3 720 kg              | 34 kPa          |

## SERVICE REFILL CAPACITIES

|  |             |
|--|-------------|
| Fuel tank .....                                | 40.0 liters |
| Engine coolant .....                           | 6.0         |
| Engine oil .....                               | 7.2         |
| Travel device (each side) .....                | 0.6         |
| Hydraulic system .....                         | 58.0        |
| Hydraulic oil tank (Reference oil level) ..... | 35.0        |

## DIMENSIONS

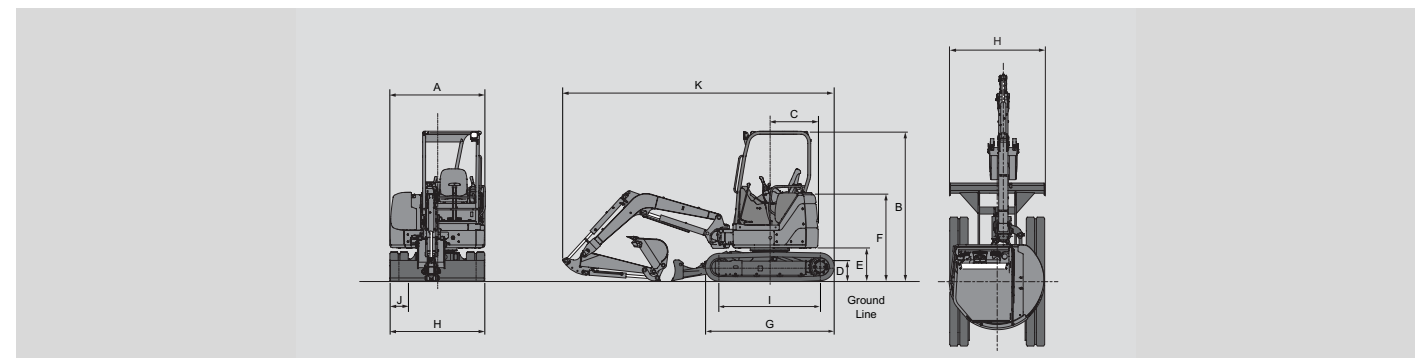

Note:

The illustration shows the ZAXIS30U<sub>2</sub> canopy version equipped with 1.17 m arm and 300 mm rubber shoes. The canopy and cabin conform to ROPS (ISO 3471) and FOPS (ISO 10262, Level 1) requirements.

|  | ZAXIS30U <sub>2</sub> |       | ZAXIS35U <sub>2</sub> |       |
|--|-----------------------|-------|-----------------------|-------|
|  | Canopy                | Cabin | Canopy                | Cabin |
| A Overall width                                    | 1 550                 |       | 1 740                 |       |
| B Overall height                                   | 2 460                 | 2 500 | 2 460                 | 2 500 |
| C Rear-end swing radius (With extra counterweight) | 775 (865)             |       | 870 (960)             |       |
| D Minimum ground clearance                         | 290                   |       | 290                   |       |
| E Counterweight clearance                          | 560                   |       | 560                   |       |
| F Engine cover height                              | 1 420                 |       | 1 420                 |       |
| G Undercarriage length                             | 2 100                 |       | 2 100                 |       |
| H Undercarriage width                              | 1 550                 |       | 1 740                 |       |
| I Sprocket centre to idler centre                  | 1 650                 |       | 1 650                 |       |
| J Track shoe width                                 | 300                   |       | 300                   |       |
| K Maximum transport length (With long arm)         | 4 450 (4 560)         |       | 4 650 (4 780)         |       |

Unit: mm

## WORKING RANGES

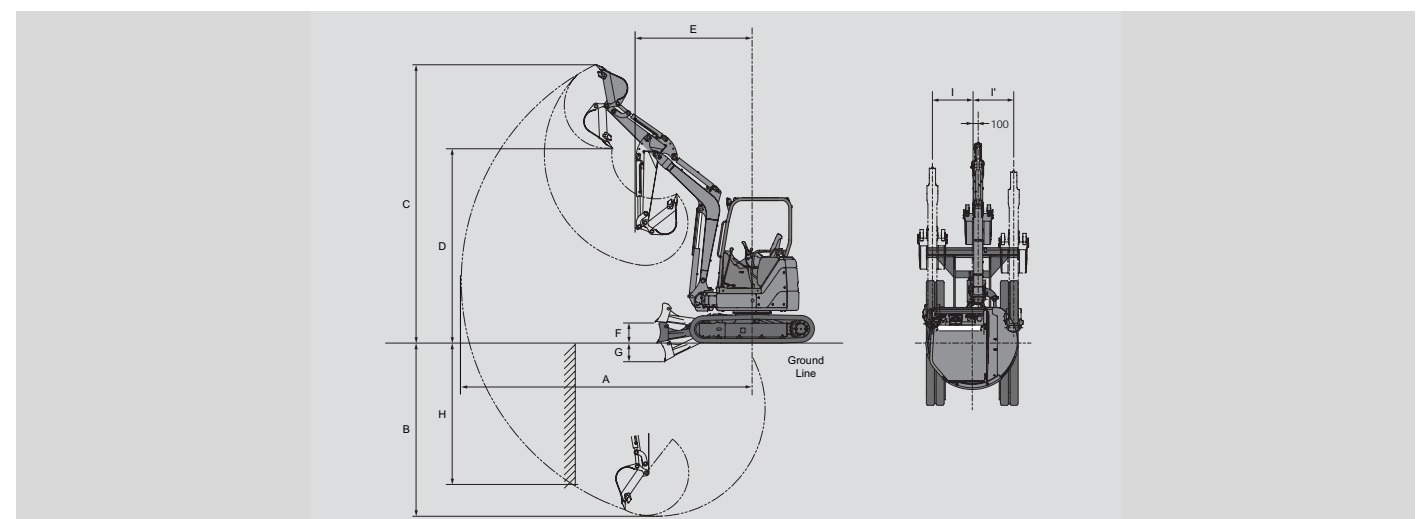

Note:

The illustration shows the ZAXIS30U<sub>2</sub> canopy version equipped with 0.09 m<sup>3</sup> bucket, 1.52 m arm and 300 mm rubber shoes.

|   | ZAXIS30U <sub>2</sub>            |                                  | ZAXIS35U <sub>2</sub>            |                                  |
|---|----------------------------------|----------------------------------|----------------------------------|----------------------------------|
|   | Canopy                           | Cabin                            | Canopy                           | Cabin                            |
| A Maximum digging reach                           | 4 900 [5 170]                    |                                  | 5 220 [5 530]                    |                                  |
| B Maximum digging depth                           | 2 830 [3 130]                    |                                  | 3 060 [3 460]                    |                                  |
| C Maximum cutting height                          | 4 680 [4 720]                    | 4 450 [4 480]                    | 4 900 [5 010]                    | 4 720 [4 820]                    |
| D Maximum dumping height                          | 3 260 [3 340]                    | 3 040 [3 130]                    | 3 490 [3 600]                    | 3 330 [3 430]                    |
| E Minimum swing radius (At maximum boom swing)    | 1 940 (1 580)<br>[2 060 (1 660)] | 2 140 (1 730)<br>[2 170 (1 730)] | 2 070 (1 670)<br>[2 170 (1 730)] | 2 230 (1 810)<br>[2 290 (2 010)] |
| F Blade bottom highest position above ground      | 360                              |                                  | 360                              |                                  |
| G Blade bottom lowest position above ground       | 315                              |                                  | 390                              |                                  |
| H Maximum vertical wall                           | 2 340 [2 460]                    |                                  | 2 670 [3 020]                    |                                  |
| I / I' Offset distance (Maximum boom-swing angle) | L 605 (72°) / R 740 (62°)        | L 605 (62°) / R 740 (62°)        | L 605 (72°) / R 740 (62°)        | L 605 (62°) / R 740 (62°)        |

The figure in [ ] shows the equipped with long arm.

## METRIC MEASURE

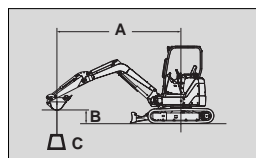

A: Load radius  
B: Load point height  
C: Lifting capacity

### ZAXIS30U-2 CANOPY VERSION, BLADE ABOVE GROUND

Rating over-side or 360 degrees Rating over-front Unit: 1 000 kg

|                            | Load point height | Load radius |      |      |      |      |      |     |  | At max. reach |  |       |
|----------------------------|-------------------|-------------|------|------|------|------|------|-----|--|---------------|--|-------|
|                            |                   | 2 m         |      | 3 m  |      | 4 m  |      | 5 m |  |               |  | meter |
|                            |                   |             |      |      |      |      |      |     |  |               |  |       |
| Arm 1.17 m                 | 3 m               |             |      |      |      |      |      |     |  |               |  | 4.21  |
| Rubber shoes 300 mm        | 2 m               |             |      | 0.55 | 0.70 | 0.33 | 0.42 |     |  |               |  | 4.61  |
| Bucket 0.09 m <sup>3</sup> | 1 m               |             |      | 0.51 | 0.65 | 0.32 | 0.41 |     |  |               |  | 4.68  |
|                            | 0 m               |             |      | 0.48 | 0.62 | 0.31 | 0.40 |     |  |               |  | 4.44  |
|                            | -1 m              | 0.91        | 1.25 | 0.48 | 0.62 |      |      |     |  |               |  | 3.79  |
| Arm 1.17 m                 | 3 m               |             |      |      |      |      |      |     |  |               |  | 4.21  |
| Rubber shoes 300 mm        | 2 m               |             |      | 0.63 | 0.80 | 0.39 | 0.49 |     |  |               |  | 4.61  |
| Bucket 0.09 m <sup>3</sup> | 1 m               |             |      | 0.59 | 0.76 | 0.38 | 0.48 |     |  |               |  | 4.68  |
|                            | 0 m               |             |      | 0.56 | 0.73 | 0.37 | 0.47 |     |  |               |  | 4.44  |
|                            | -1 m              | 1.07        | 1.44 | 0.56 | 0.72 |      |      |     |  |               |  | 3.79  |
| Extra counterweight 190 kg |                   |             |      |      |      |      |      |     |  |               |  |       |

### ZAXIS30U-2 CANOPY VERSION, BLADE ON GROUND

Unit: 1 000 kg

|                            | Load point height | Load radius |       |      |       |      |       |     |  | At max. reach |  |       |
|----------------------------|-------------------|-------------|-------|------|-------|------|-------|-----|--|---------------|--|-------|
|                            |                   | 2 m         |       | 3 m  |       | 4 m  |       | 5 m |  |               |  | meter |
|                            |                   |             |       |      |       |      |       |     |  |               |  |       |
| Arm 1.17 m                 | 3 m               |             |       |      |       |      |       |     |  |               |  | 4.21  |
| Rubber shoes 300 mm        | 2 m               |             |       | 0.55 | *0.83 | 0.33 | *0.76 |     |  |               |  | 4.61  |
| Bucket 0.09 m <sup>3</sup> | 1 m               |             |       | 0.51 | *1.19 | 0.32 | *0.86 |     |  |               |  | 4.68  |
|                            | 0 m               |             |       | 0.48 | *1.39 | 0.31 | *0.93 |     |  |               |  | 4.44  |
|                            | -1 m              | 0.91        | *2.09 | 0.48 | *1.30 |      |       |     |  |               |  | 3.79  |
| Arm 1.17 m                 | 3 m               |             |       |      |       |      |       |     |  |               |  | 4.21  |
| Rubber shoes 300 mm        | 2 m               |             |       | 0.63 | *0.83 | 0.39 | *0.76 |     |  |               |  | 4.61  |
| Bucket 0.09 m <sup>3</sup> | 1 m               |             |       | 0.59 | *1.19 | 0.38 | *0.86 |     |  |               |  | 4.68  |
|                            | 0 m               |             |       | 0.56 | *1.39 | 0.37 | *0.93 |     |  |               |  | 4.44  |
|                            | -1 m              | 1.07        | *2.09 | 0.56 | *1.30 |      |       |     |  |               |  | 3.79  |
| Extra counterweight 190 kg |                   |             |       |      |       |      |       |     |  |               |  |       |

### ZAXIS35U-2 CANOPY VERSION, BLADE ABOVE GROUND

Unit: 1 000 kg

|                            | Load point height | Load radius |      |       |       |      |      |     |  | At max. reach |  |       |
|----------------------------|-------------------|-------------|------|-------|-------|------|------|-----|--|---------------|--|-------|
|                            |                   | 2 m         |      | 3 m   |       | 4 m  |      | 5 m |  |               |  | meter |
|                            |                   |             |      |       |       |      |      |     |  |               |  |       |
| Arm 1.32 m                 | 3 m               |             |      |       |       | 0.47 | 0.48 |     |  |               |  | 4.58  |
| Rubber shoes 300 mm        | 2 m               |             |      | 0.75  | 0.78  | 0.46 | 0.48 |     |  |               |  | 4.94  |
| Bucket 0.11 m <sup>3</sup> | 1 m               |             |      | 0.69  | 0.72  | 0.44 | 0.46 |     |  |               |  | 5.00  |
|                            | 0 m               |             |      | 0.66  | 0.69  | 0.42 | 0.44 |     |  |               |  | 4.78  |
|                            | -1 m              | 1.28        | 1.37 | 0.65  | 0.68  | 0.42 | 0.43 |     |  |               |  | 4.22  |
| Arm 1.32 m                 | 3 m               |             |      |       |       | 0.55 | 0.58 |     |  |               |  | 4.58  |
| Rubber shoes 300 mm        | 2 m               |             |      | *0.86 | *0.86 | 0.55 | 0.57 |     |  |               |  | 4.94  |
| Bucket 0.11 m <sup>3</sup> | 1 m               |             |      | 0.82  | 0.86  | 0.53 | 0.55 |     |  |               |  | 5.00  |
|                            | 0 m               |             |      | 0.78  | 0.82  | 0.51 | 0.53 |     |  |               |  | 4.78  |
|                            | -1 m              | 1.50        | 1.61 | 0.77  | 0.81  | 0.51 | 0.53 |     |  |               |  | 4.22  |
| Extra counterweight 230 kg |                   |             |      |       |       |      |      |     |  |               |  |       |

### ZAXIS35U-2 CANOPY VERSION, BLADE ON GROUND

Unit: 1 000 kg

|                            | Load point height | Load radius |       |       |       |      |       |     |  | At max. reach |  |       |
|----------------------------|-------------------|-------------|-------|-------|-------|------|-------|-----|--|---------------|--|-------|
|                            |                   | 2 m         |       | 3 m   |       | 4 m  |       | 5 m |  |               |  | meter |
|                            |                   |             |       |       |       |      |       |     |  |               |  |       |
| Arm 1.32 m                 | 3 m               |             |       |       |       | 0.47 | *0.71 |     |  |               |  | 4.58  |
| Rubber shoes 300 mm        | 2 m               |             |       | 0.75  | *0.86 | 0.46 | *0.77 |     |  |               |  | 4.94  |
| Bucket 0.11 m <sup>3</sup> | 1 m               |             |       | 0.69  | *1.30 | 0.44 | *0.91 |     |  |               |  | 5.00  |
|                            | 0 m               |             |       | 0.66  | *1.55 | 0.42 | *1.02 |     |  |               |  | 4.78  |
|                            | -1 m              | 1.28        | *2.24 | 0.65  | *1.50 | 0.42 | *0.99 |     |  |               |  | 4.22  |
| Arm 1.32 m                 | 3 m               |             |       |       |       | 0.55 | *0.71 |     |  |               |  | 4.58  |
| Rubber shoes 300 mm        | 2 m               |             |       | *0.86 | *0.86 | 0.55 | *0.77 |     |  |               |  | 4.94  |
| Bucket 0.11 m <sup>3</sup> | 1 m               |             |       | 0.82  | *1.30 | 0.53 | *0.91 |     |  |               |  | 5.00  |
|                            | 0 m               |             |       | 0.78  | *1.55 | 0.51 | *1.02 |     |  |               |  | 4.78  |
|                            | -1 m              | 1.50        | *2.24 | 0.77  | *1.50 | 0.51 | *0.99 |     |  |               |  | 4.22  |
| Extra counterweight 230 kg |                   |             |       |       |       |      |       |     |  |               |  |       |

Notes:  
1. Ratings are based on SAE J1097.  
2. Lifting capacity does not exceed 75% of tipping load with the machine on firm, level ground or 87% full hydraulic capacity.  
3. The load point is a hook (not standard equipment) located on the back of the bucket.  
4. An asterisk mark (\*) indicates load limited by hydraulic capacity.

## STANDARD EQUIPMENT

Standard equipment may vary by country, so please consult your Hitachi dealer for details.

### ENGINE

- Water-separator for engine fuel system
- Auto-idling system

### HYDRAULIC SYSTEM

- Hydraulic pilot type control levers
- Pilot control shut-off levers
- Anti-drift valve for front attachments
- Two-speed travel system
- Swing parking brake
- Travel parking brake
- Piping for attachments

### CANOPY (CABIN)

- ROPS/FOPS\*\*
- Adjustable reclining seat\*\*
- Seat belt\*\*
- Wrist rest\*\*
- Seat backrest box\*\*
- Air conditioner\*\*\*
- Defroster\*\*\*
- Windshield wiper\*\*\*
- Windshield washer\*\*\*
- Two work lights\*\*
- AM/FM radio\*\*\*
- 12 V outlet\*\*
- Ashtray\*\*\*
- Drink holder\*\*
- Utility box\*
- Rear view mirror\*\*
- Evacuation hammer\*\*\*

### Notes:

- \* For canopy versions
- \*\* For canopy and cabin versions
- \*\*\* For cabin versions

## OPTIONAL EQUIPMENT

Optional equipment may vary by country, so please consult your Hitachi dealer for details.

### HYDRAULIC SYSTEM

- Swing motion alarm device with lamp
- Travel motion alarm device
- Extra oil flow selector\*\*

### CANOPY (CABIN)

- 2-way control lever pattern selector valve
- Suspension seat\*\*
- Auxiliary light\*\*
- Air cleaner inner element

### Notes:

- \* For canopy versions
- \*\* For canopy and cabin versions
- \*\*\* For cabin versions

### UNDERCARRIAGE

- 300 mm rubber shoes
- Semi-long stay blade

### FRONT ATTACHMENTS

- O-ring type pin-seals for hoe bucket
- HN bushing
- WC spraying
- ZAXIS30U-2
  - 2.28 m boom
  - 1.17 m arm
  - 0.09 m<sup>3</sup> hoe bucket
- ZAXIS35U-2
  - 2.47 m boom
  - 1.38 m arm
  - 0.11 m<sup>3</sup> hoe bucket

### UNDERCARRIAGE

- 300 mm grouser shoes
- 300 mm pad crawler shoes
- Long stay blade

### FRONT ATTACHMENTS

- ZAXIS30U-2
  - 1.52 m arm
  - Backhoe buckets
- ZAXIS35U-2
  - 1.72 m arm
  - Backhoe buckets

### COUNTERWEIGHT

- Extra counterweight
- ZAXIS30U-2 : 190 kg
- ZAXIS35U-2 : 230 kg

 **Hitachi Construction Machinery Co., Ltd.**

Head Office : 5-1, Koraku 2-chome, Bunkyo-ku  
Tokyo 112-8563, Japan  
Telephone : 81-3-3830-8050  
Facsimile : 81-3-3830-8204  
URL : [www.hitachi-c-m.com](http://www.hitachi-c-m.com)

These specifications are subject to change without notice.  
Illustrations and photos show the standard models, and may or may not include  
optional equipment, accessories, and all standard equipment.  
Before use, go through Operator's Manual for proper operation.